

AI Motorized Dome Network Camera



IP67 + IK10

Motorized Lens



DATASHEET

KEY FEATURES

- ▶ Smart IR II (Combining the High Beam and Low Beam to adjust IR intensity to fit different lighting conditions.)
- ▶ 100fps High Frame Rate (Camera can easily catch images with no latency despite of the high-speed movement.)
- ▶ P-Iris (Giving you a more clear scene with depth of view.)
- ▶ SIP (Session Initiation Protocol. Providing audio/alarm/intercom and video streaming for mobile phones and video phones.)
- ▶ 256G (Supporting ultra-large external microSD/SDHC/SDXC card storage up to 256G.)
- ▶ Smart Stream (Bandwidth, storage and bit rate are saved with Smart Stream On, eg, H.265+ saves 70%~80% bandwidth that of H.264.)

AI Video Analytics

- 8 intelligent VCA modes powered by AI engine, which can intelligently filter objects to focus on human and vehicle detection.
- People Counting technology provides high accuracy and real-time data based on AI algorithm with statistic reports.
- Face Detection function detects human faces in the monitoring scene and captures the snapshots, which greatly enhances the monitoring efficiency.



3 in 1 Super WDR Pro - 140 dB

The upgraded 3 in 1 Super WDR Pro outputs three frames each line, which is able to bring more details especially moving subjects. What's more, it greatly improves image quality for reducing smear and noisy points. The ratio that the brightest light signal values divided by the darkest light signal values is up to 140dB.



0.005Lux Ultra Low-light

The starlight camera is able to deliver high detailed color images even in low light environment reaching 0.005Lux(Color) or 0Lux(B/W), and near infrared light environments without any supplementary lighting.

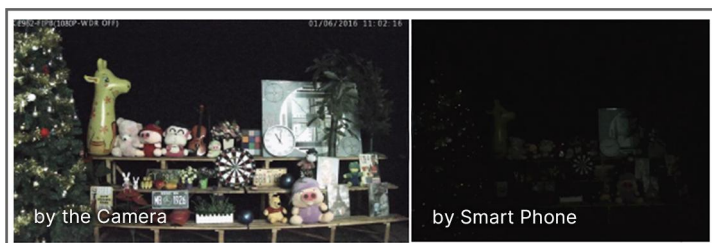

30fps@4K

Providing 4K HD resolution with frame rate of 30fps, the camera performs well in catching detailed image regardless of the moving speed.

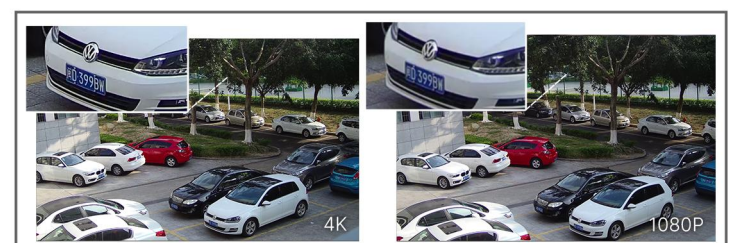

AI Motorized Dome Network Camera



	Model	MS-C2975-R(T)F(I)PC (2MP)	MS-C5375-F(I)PC (5MP)	MS-C8175-F(I)PC (4K)
Camera	Image Sensor	1/2.8" Progressive Scan CMOS		
	Min. Illumination	Color: 0.005Lux@F1.4 B/W: 0Lux with IR on	Color: 0.008Lux@F1.4 B/W: 0Lux with IR on	Color: 0.012Lux@F1.4 B/W: 0Lux with IR on
	WDR	140dB Super WDR (Super WDR Pro is optional for T Series)	120dB Super WDR	
	Shutter Time	1/100000s~1s		
	IR Distance	Up to 50m		
	Day/Night Mode	Day/Night/Auto/Customize/Schedule		
	S/N	>55dB		
Lens	Lens	Motorized 2.7~13.5mm/3.0~10.5mm/7~22mm@F1.4 P-Iris(Optional)		Motorized 2.7~13.5mm@F1.4 P-Iris(Optional)
	Field of View	H111°~H34°/D130°~D39°/ V60°~V19°(2.7~13.5mm) H100°~H33°/D115°~D38°/ V54°~V18°(3.0~10.5mm) H42°~H17°/D48°~D19°/ V24°~V9°(7~22mm)	H99°~H31°/D124°~D38°/ V72°~V23°(2.7~13.5mm) H89°~H31°/D111°~D38°/ V66°~V23°(3.0~10.5mm) H37°~H15°/D46°~D19°/ V28°~V11°(7~22mm)	H107°~H33°/D125°~D37° /V58°~V18°
	Mount	Φ14		
	Focus Control	Auto/Manual		
	Iris Control (Optional for I Series)	Auto/Manual		
	Video	Max. Image Resolution	1920x1080	2592x1944
Primary Stream		60Hz: 100fps@(1920x1080)(Optional for T Series), 60fps@(1920x1080,1280x960, 1280x720, 704x576) 50Hz: 100fps@(1920x1080)(Optional for T Series), 50fps@(1920x1080,1280x960, 1280x720, 704x576)	60Hz: 30fps@(2592x1944), 45fps@(2048x1536), 60fps@(1920x1080, 1280x960, 1280x720, 704x576) 50Hz: 25fps@(2592x1944), 45fps@(2048x1536), 50fps@(1920x1080, 1280x960, 1280x720, 704x576)	60Hz: 30fps@(3840x2160, 3072x2048, 2592x1944, 2592x1520, 2048x1536, 1920x1080, 1280x960, 1280x720, 704x576) 50Hz: 25fps@(3840x2160, 3072x2048, 2592x1944, 2592x1520, 2048x1536, 1920x1080, 1280x960, 1280x720, 704x576)
Secondary Stream		60Hz: 60fps@(704x576, 640x480, 640x360, 352x288, 320x240, 320x192, 320x180) 50Hz: 50fps@(704x576, 640x480, 640x360, 352x288, 320x240, 320x192, 320x180)	60Hz: 30fps@(704x576, 640x480, 640x360, 352x288, 320x240, 320x192, 320x180) 50Hz: 25fps@(704x576, 640x480, 640x360, 352x288, 320x240, 320x192, 320x180)	
Tertiary Stream		60Hz: 30fps@(1920x1080, 1280x720, 704x576, 640x480, 640x360, 320x240, 320x192, 320x180) 50Hz: 25fps@(1920x1080, 1280x720, 704x576, 640x480, 640x360, 320x240, 320x192, 320x180)		
Video Compression		H.265+/H.265(HEVC)/H.264+/H.264/MJPEG		
Video Bit Rate		16Kbps~16Mbps(CBR/VBR Adjustable)		
Privacy Masking		Up to 28 areas(24 mask areas and 4 mosaic areas)		
ROI		Up to 8 areas		
Image Setting	Brightness/Contrast/Saturation/Sharpness			

AI Motorized Dome Network Camera



Interface	Ethernet	1*RJ45 10M/100M Ethernet Port
	Audio I/O	Built-in Microphone; 1/1 (Multi-interface Version)
	Alarm I/O	1/1 (Multi-interface Version)
Network	Network Storage	NAS(Support NFS, SMB/CIFS), ANR
	Protocol	IPv4/IPv6, ARP, TCP, UDP, RTCP, RTP, RTSP, RTMP, HTTP, HTTPS, DNS, DDNS, DHCP, FTP, NTP, SMTP, SNMP, UPnP, Bonjour, SIP, PPPoE, VLAN, 802.1x, QoS, IGMP, ICMP, SSL
Audio	Audio Compression	G.711/AAC/G.722/G.726
	Audio Sampling Rate	8/16/32/44.1/48KHz
	Audio Bit Rate	16~256kbps
	Two-way Audio	Support
Intelligent Analytics	Video Analysis	Region Entrance, Region Exiting, Advanced Motion Detection, Tamper Detection, Line Crossing, Loitering, Object Left, Object Removed
	Face Detection	Detect and capture faces, get real-time snapshots
	People Counting&Report	Count the number of people entering or exiting, up to 4 detection areas for regional people counting
System	Storage	Support microSD/SDHC/SDXC Card Local Storage, up to 256G
	Advanced Function	Heat Map, BLC, HLC, 2D DNR, 3D DNR, Defog, AWB, EIS, IP Address Filtering, AGC, Anti-flicker, Corridor Mode, Deblur, Watermark
	SIP/VoIP Support	Yes, Voice & Video-over-IP
	Event Trigger	Motion Detection, Network Disconnection, External Input, Audio Alarm, etc.
	Event Action	FTP Upload, SMTP Upload, SD Card Record, External Output, SIP Phone, HTTP Notification, etc.
	System Compatibility	ONVIF Profile G & Q & S & T, API
General	Working Temperature	-40°C~60°C
	Working Humidity	0~90%(Non-condensing)
	Power Supply	PoE (802.3af); PoE (802.3af) / DC 12V ± 10% (Multi-interface Version)
	Power Consumption	8W MAX 9W MAX (With IR on) 7W MAX 9W MAX (With IR on) 8W MAX 9W MAX (With IR on)
	Housing	Vandal-proof IK10-rated Metal Housing / Up to IP67-rated for Weather-resistant Performance
	Weight	780g
	Dimensions	Φ130mmX115mm
	Warranty	3/5 Years

AI Motorized Dome Network Camera



Structure Diagrams

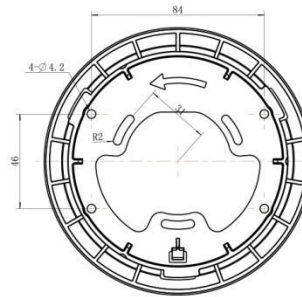
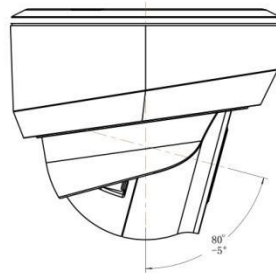
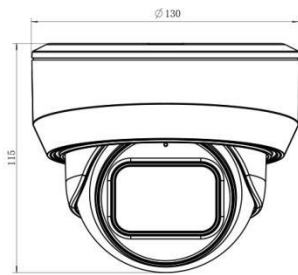
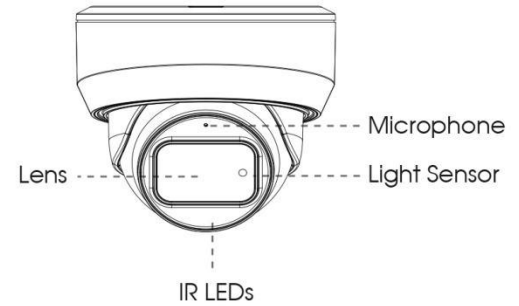
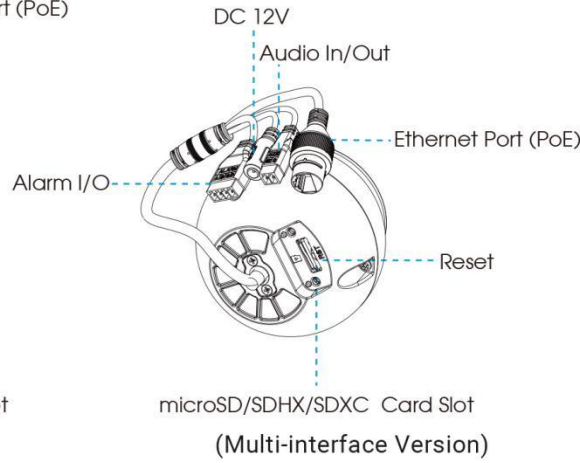
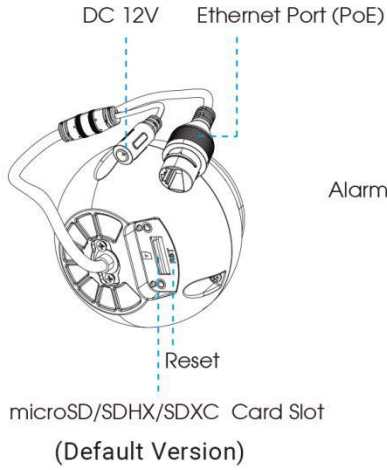

Units: mm

Accessories Support

A01 Pole Mount

Weight: 720g
Dimensions: 170*51.5*152.6mm



A03 External Corner Bracket

Weight: 900g
Dimensions: 170*152.5*76.3mm



A71 Wall Mount

Weight: 530g
Dimensions: 162*124*78 mm



Milesight Technology | www.milesight.com
Contact Us: sales@milesight.com support@milesight.com

Add: 220 NE 51st Street, Oakland Park, Florida 33334, USA
Tel: +1-800-561-0485

Add: 925, Anyang SK V1 Center, LS-ro 116beon-gil, Dongan-gu, Anvng-si, Korea
Tel: +82-31-990-7732

Add: Building C09, Software Park Phase III, Xiamen 361024, Fujian, China
Tel: +86-592-5922772

